

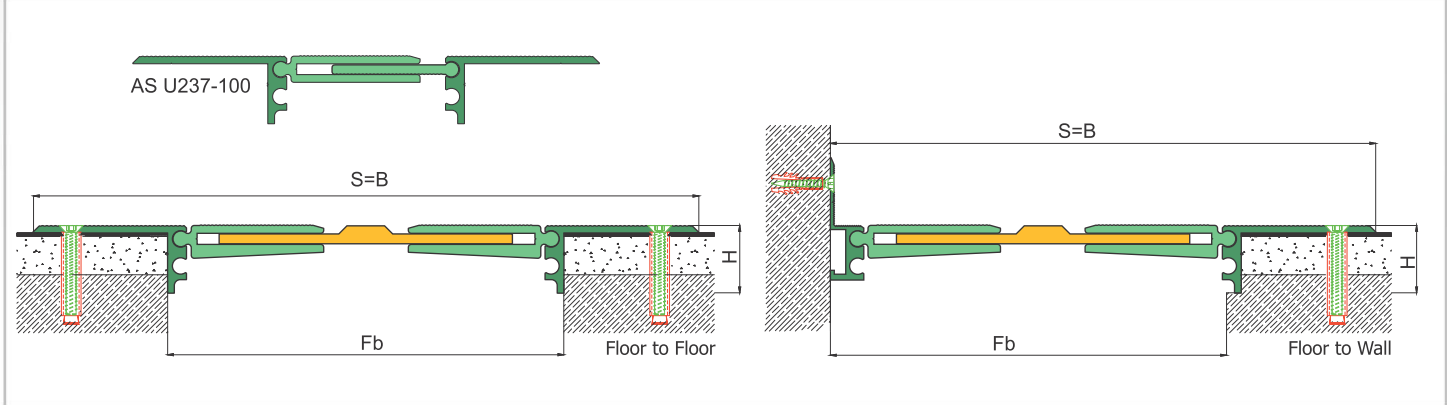

AS U237 surface mounted floor profiles are applicable to all types of floors and load bearing capacity is designed for heavy vehicles or cars depending on the gap inquired. Pure metal structure characterizes AS U237 as a hardwearing & maintenance free profile and makes it ideal for the places with heavy pedestrian traffic. Striated surface finish ensures antislip and round-headed articulated design enables the profile to meet displacements in 3 directions. Profiles are delivered factory-assembled and for some gaps soft EPDM tape is placed on the center plate to align the distance between the side frames. For flush mounted applications AS A227 model is available.

- Application Areas** : Indoor & Outdoor / Floor
- Ideal for** : Factories, Warehouses, Car Parks, Airports, Shopping Malls, Hospitals, Commercial & Public Buildings etc.
- Material** : Mill Finish Aluminum (Anodizing optional), Soft EPDM tape
- Aluminum Alloy** : 6063 AA-USA / EN AW 6063
- Optional Supplies** : Fire Barrier, Waterproof EPDM membrane

FLOOR

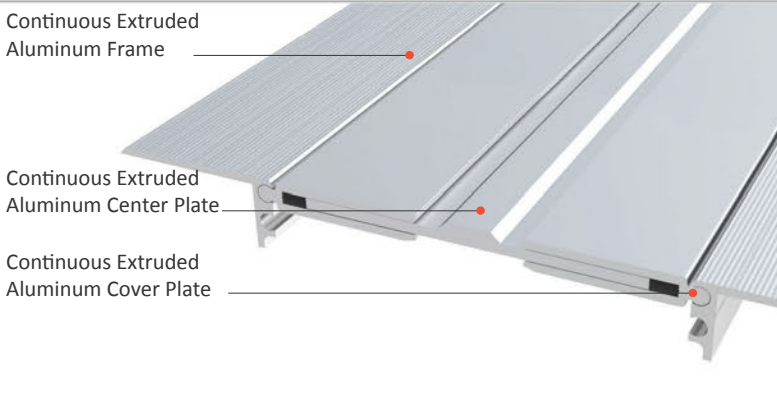

* Visuals are representative and the profile configuration may differ depending on the characteristics requested.

LOCATION	MODEL	GAP (Fb) mm	HEIGHT (H) MM	OVERALL WIDTH (B) mm	VISIBLE WIDTH (S) mm	MOVEMENT (W) mm	LOAD CAPACITY	STANDARD LENGTH (mt)
Floor to Floor	AS U237-060	60	35	200	200	± 8	35 kN 300 kN	3
	AS U237-080	80	35	220	220	± 4	25 kN 120 kN	3
	AS U237-100	100	35	240	240	± 10		3
	AS U237-120	120	35	260	260	± 18		3
	AS U237-150	150	35	290	290	± 20		3
	AS U237-180	180	35	320	320	± 20		3
	AS U237-200	200	35	340	340	± 20		3

Note: Please ask for different sizes



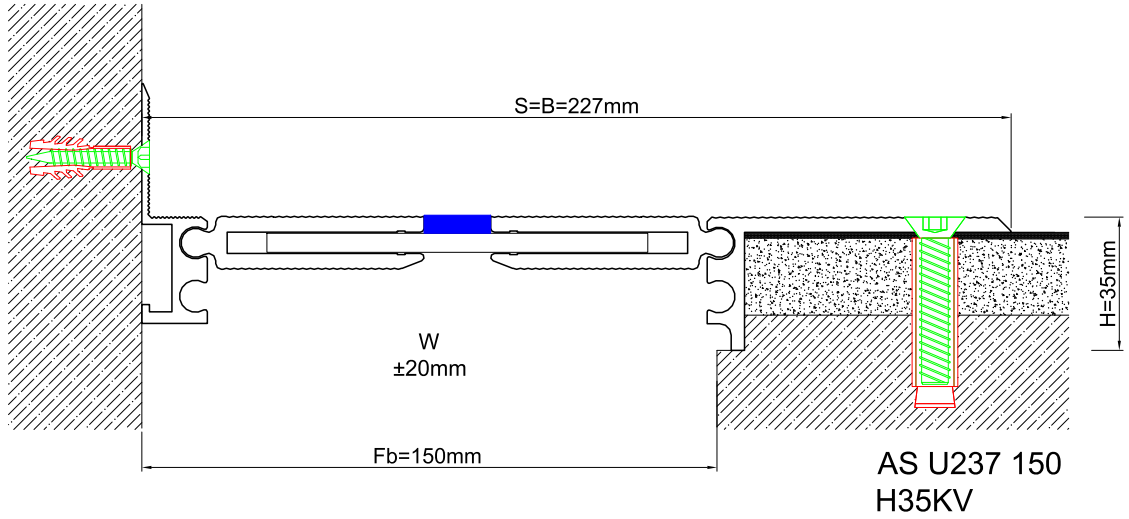
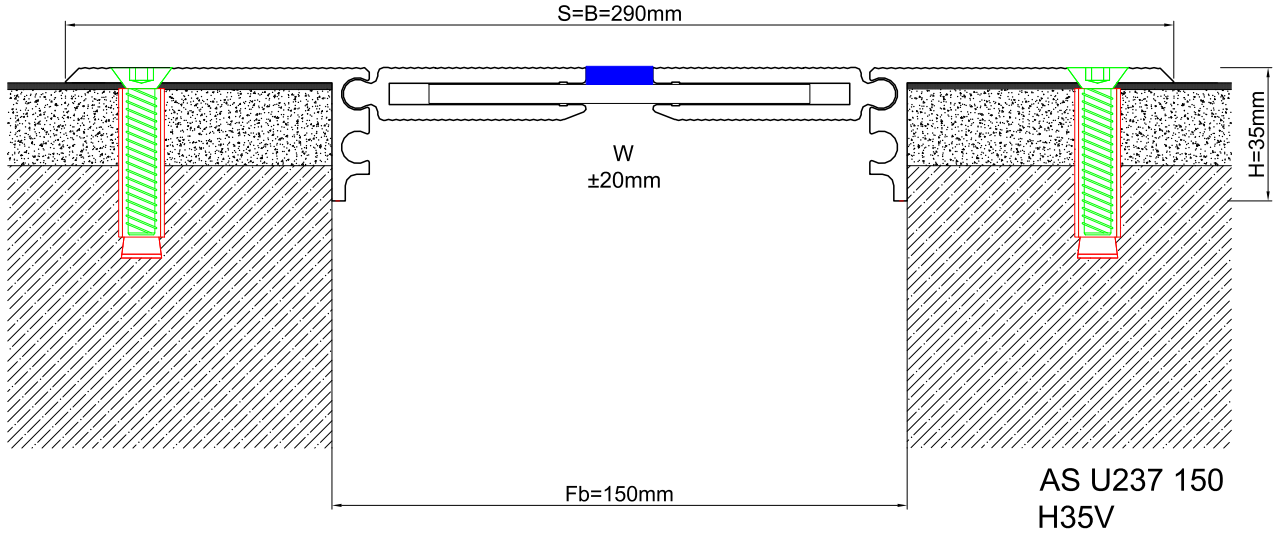

Profil No Profile Number	AS U237 150	AS U237 150K
Fb (mm)	150	150
H (mm) yaklaşık approx.	35	35
W± (mm) yaklaşık approx.	±20	±20
Renk Color	Alüminyum: Natürel Aluminum: Natural	
Malzeme Material	Alüminyum Aluminum	
Standart Uzunluk Standard Length	3	
Yükleme Kapasitesi Load-Bearing Capacity	